

GAS BUILT-IN RANGE

EW30GS80RS

Featuring Wave-Touch® Electronic Controls



PRODUCT DIMENSIONS

Height	36-5/8"
Width	30"
Depth	28-5/16"

MORE EASY-TO-USE FEATURES

PERFECT TURKEY® BUTTON

Ensures moist, delicious poultry. Imagine stress-free holiday cooking as the Perfect Taste™ Temp Probe helps you deliver a perfectly cooked turkey.

SELF-CLEAN PORCELAIN RACKS

Bake, roast, broil, savor - the cleaning's on us. Our porcelain racks are safe to stay inside of the oven during the self-clean cycle, virtually eliminating the mess and inconvenience of removing and cleaning racks by hand.

A LUXURY-GLIDE® OVEN RACK

With a ball bearing system, the oven rack is so smooth it extends effortlessly so you can more easily manage the transfer of all dishes, even heavy ones.

CONTINUOUS GAS GRATES

Designed for cooking multiple dishes at a time, these grates allow easy movement of even the heaviest pots and pans from burner to burner — without lifting. Plus, they create a streamlined look.

DEEP-WELL DESIGN

Keeps spills contained for easy cleanup.

LARGE CAPACITY

Coordinate an entire meal — our ovens feature 4.5 cu. ft. of cooking space with three adjustable baking racks.

PLATINUM STAR® LIMITED WARRANTY

Our exclusive limited warranty that includes 3-year coverage on parts and one year on labor.¹

ADA COMPLIANT

When properly installed, this model is A.D.A.-qualified based on the United States Access Board's A.D.A./A.B.A. Accessibility Guidelines and the Department of Justice's 2010 A.D.A. Standards for Accessible Design.

Available in:



Stainless
(S)

SIGNATURE FEATURES



PERFECT TASTE™ CONVECTION

For consistently delicious taste and texture, home chefs rely on our convection heat, which circulates air evenly for better baking.



PERFECT TASTE™ TEMP PROBE

The Perfect Taste™ Temp Probe lets you cook each dish to perfection. It does more than measure temperature — it alerts you when food has reached the desired temperature and automatically adjusts to the Keep Warm setting so you never overcook your food and deliver perfect results every time.



MIN-2-MAX® GAS BURNER

Designed with a dual-flame sealed burner, this cooktop provides exceptional power and precision for the widest range of flavor possibilities.



MULTI-STAGE COOKING

Create great taste with ease. With Multi-Stage Cooking, an Electrolux oven is a built-in sous chef, helping you conquer delicious by adjusting between seven professionally inspired cooking modes, including Bake, Broil, Convection Bake, Convection Roast, Convection Broil, Keep Warm and Slow Cook.

BURNER	BTU
Min-2-Max® Dual-Flame Burner	750-18,000
Sealed Power Burner	16,000
Sealed Precision Burner	9,500
Sealed Precision Burner	5,000
Center Burner	9,500

¹Eligibility based on product registration with Electrolux North America within 60 days of purchase. Products must have been purchased on or after July 1, 2013. Coverage includes material parts for 3 years and labor for 1 year.

GAS BUILT-IN RANGE

EW30GS80RS



30" GAS BUILT-IN RANGE

CONTROL PANEL FEATURES

Wave-Touch® Electronic Oven Control	Yes
Professional-Grade Burner Controls	Yes
Keypad Entry of Time & Temperature	Yes
Electronic Clock & Timer	Yes
Temperature Display	Yes
Automatic Oven (Delay, Cook & Off)	Yes

COOKTOP FEATURES

Min-2-Max Dual-Flame Sealed Burner® – 750-18,000 BTU	1
Sealed Power Burner – 16,000 BTU	1
Sealed Precision Burner – 9,500 BTU	1
Sealed Precision Burner – 5,000 BTU	1
Sealed Center Burner – 9,500 BTU	1
Linear Flow Burner Valves	Yes
Seamless Cooktop	Yes
Continuous Grates with Deep-Well Top	3
Electronic Pilotless Ignition	Yes

OVEN FEATURES

Capacity	4.5 Cu. Ft.
Hidden Bake Burner	Yes
Bake Burner – 18,000 BTU	Yes
Broil Burner – 11,500 BTU	Yes
Convection Burner – 350 Watts	Yes
Cobalt Blue Interior	Yes
Self-Clean Options with Door Lock	Yes
Perfect Taste™ Convection	Yes
Cooking Modes – Bake, Broil, Convection Bake, Convection Roast, Keep Warm, Slow Cook	7
Baking Options – Perfect Turkey®, Defrost, Dehydrate, Bread Proof, My Favorites, Multi-Stage Cooking, Temperature Probe, Rapid Preheat, Delay Bake, Convection Convert	10
Luxury-Design® Lighting with Dual 25W Halogen Bulbs	Yes
Luxury-Glide® Racks	1
Conventional Racks	2
Convection Roasting Rack	Yes

ADDITIONAL FEATURES

Extra-Large Glass Window	Yes
Warmer Drawer	Yes
Adjustable Leveling Legs	4
Sabbath Mode (Star-K® Certified)	Yes
A.D.A. Compliant*	Yes

ACCESSORIES

Porcelain Broiler Pan and Insert	Included
Grill / Griddle	Mailing Card
LP Gas Conversion Kit	Included
2" Rear Filler Kit – PN# 903113-9010	Optional
Side Panel Kit – PN# A01529901	Optional

SPECIFICATIONS

Color – Stainless Steel	S
Gas / Power Supply Connection Location	Right Bottom Rear
Voltage Rating	120V / 60Hz / 15A
Amps @ 120 Volts	10 Amps
Shipping Weight (Approx.)	270 Lbs.

*When properly installed, this model is A.D.A.-qualified based on the United States Access Board's A.D.A./A.B.A. Accessibility Guidelines and the Department of Justice's 2010 A.D.A. Standards for Accessible Design.

NOTE: Always consult local and national electric and gas codes. Refer to Product Installation Guide for detailed installation instructions on the web at electroluxappliances.com. Specifications subject to change.

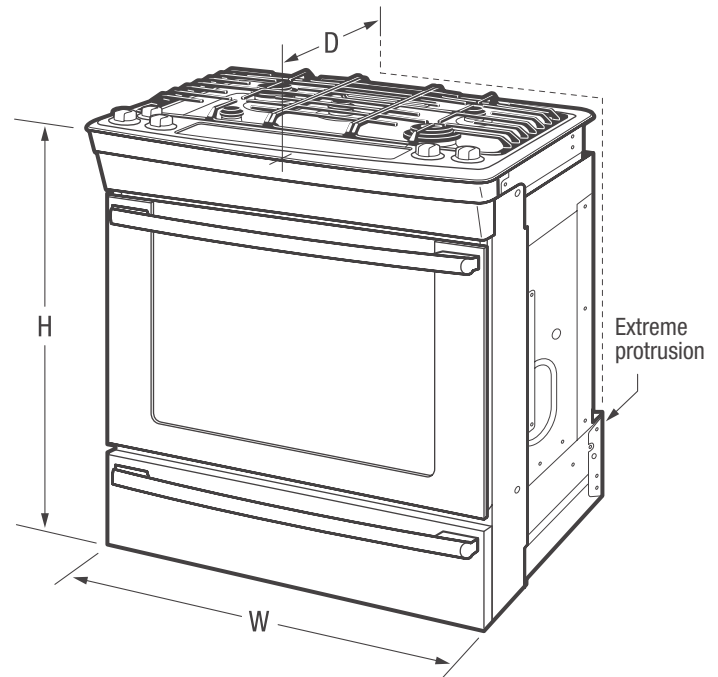

PRODUCT DIMENSIONS

Height (Adjustable)	36-5/8"
Width	30"
Depth (to Center of Arc) (with 90° Door Open)	28-5/16" 47-9/16"

OVEN CAVITY DIMENSIONS

Height	17-1/2"
Width	24-1/8"
Depth	18-3/4"

Electrolux Major Appliances, N.A.

USA 10200 David Taylor Drive Charlotte, NC 28262 1-877-4electrolux (1-877-435-3287) electroluxappliances.com
 CANADA 5855 Terry Fox Way Mississauga, ON L5V 3E4 1-800-265-8352 electroluxappliances.ca

EW30GS80R 06/15

© 2015 Electrolux Home Products, Inc.



High standards of quality at Electrolux Home Products, Inc. mean we are constantly working to improve our products. We reserve the right to change specifications or discontinue models without notice.